

new@forster

RC3 Einbruchhemmung für Brandschutztüren und -verglasungen Anti-effraction CR3 pour portes et vitrages coupe-feu RC3 burglary-resistance for fire-protection doors and glazings



Brandschutztüren EI30 Verglasungen EI30/EI60

- Bis 2.5 m lichte Durchgangshöhe
- Sicherheits-Mehrpunktschloss selbstverriegelnd
- Vorgerichtete Profile für Mehrpunktschloss
- Schwellenlos möglich
- Ein- und auswärtsöffnend
- Selbstverriegelnder Standflügel
- Antipanik auf Anfrage

Portes coupe-feu EI30 Cloisons EI30/EI60

- Hauteur de passage libre jusqu'à 2.5 m
- Serrure de sécurité multipoint avec verrouillage automatique
- Profilés préentaillés pour serrures multipoints
- Possible sans seuil
- Ouverture vers l'intérieur et l'extérieur
- Vantail dormant avec condamnation automatique
- Anti-panique sur demande

Fire-protection doors EI30 Glazings EI30/EI60

- Inside height up to 2.5 m
- Self-locking safety multiple lock
- Prepared profiles for safety multiple lock
- Without threshold
- Inwards and outwards opening
- Self-locking fixed leaf
- Anti-panic on request

Systemübersicht

Aperçu du système

System overview

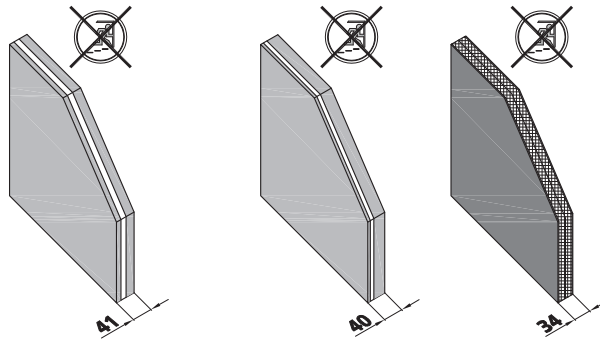

EI 30	Türen / Verglasungen Portes / cloisons Doors / glazing	Pyrostop® 30-18 P5A 41 mm	Contraflam Climaplus® 30-2 P5A 40 mm	Panel Typ B - 2 x 2 mm Stahl / Acier / Steel CrNi - 2 x 15 mm GKF
EI 60	Verglasungen Cloisons Glazing	Pyrostop® 60-181 P5A 41 mm		Panel Typ B - 2 x 2 mm Stahl / Acier / Steel CrNi - 2 x 15 mm Gifboard
Weitere Füllungen auf Anfrage / Autres remplissages sur demande / further fillings upon request				

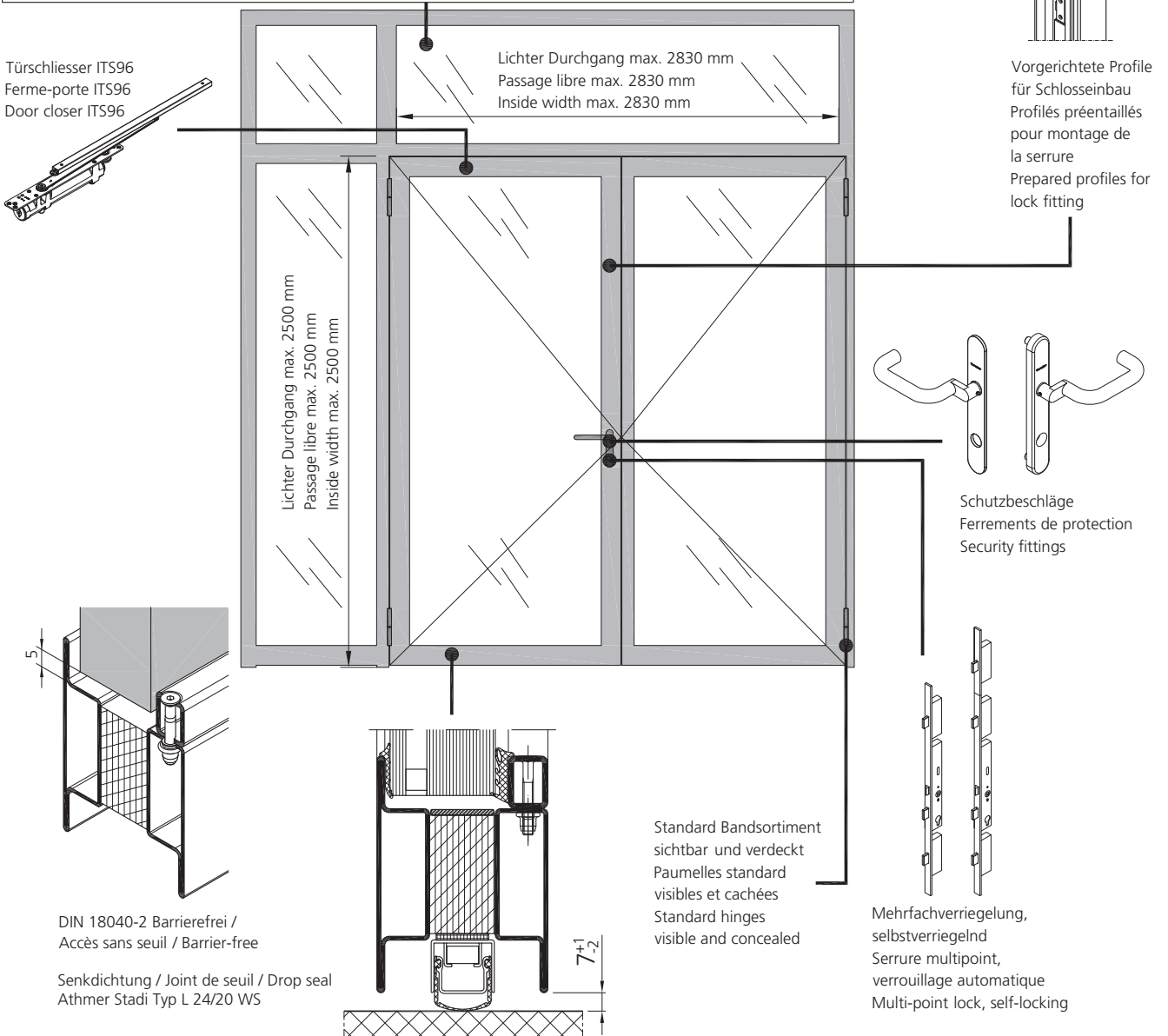

Systemübersicht

Aperçu du système

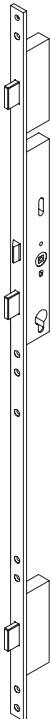
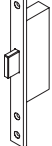
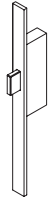
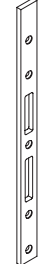
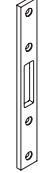

System overview

Abbildung Figure Figure	Bezeichnung Désignation Designation	Verkaufseinheit Unité de vente Sales unit	Art. Nr. art. no. art. no.
	<p>Mehrfachverriegelung, 3-Punkt, selbstverriegelnd, PZ, RC3, DIN links/rechts, ohne Antipanik-Funktion, DM 35 mm, Stulp 24 x 6 mm, L = 1760 mm <i>Serrure 3 points, verrouillage automatique, CP, CR3, DIN gauche/droite, sans fonction anti-panique, dist. au canon 35 mm, tête 24 x 6 mm, L = 1760 mm</i> Multiple lock, 3 point, self-locking, PC, RC3, DIN left/right, without anti-panic function, backset 35 mm, front plate 24 x 6 mm, L = 1760 mm</p> <p>Befestigungs-Set 957324 separat bestellen. <i>Commander séparément le kit de fixation 957324.</i> Order fastening set 957324 separately.</p>	<p>1 Stk. / pce</p>	<p>906443</p>
	<p>Mehrfachverriegelung, 3-Punkt, selbstverriegelnd, RZ, RC3, DIN links/rechts, ohne Antipanik-Funktion, DM 35 mm, Stulp 24 x 6 mm, L = 1760 mm <i>Serrure 3 points, verrouillage automatique, CR, CR3, DIN gauche/droite, sans fonction anti-panique, dist. au canon 35 mm, tête 24 x 6 mm, L = 1760 mm</i> Multiple lock, 3 point, self-locking, RC, RC3, DIN left/right, without anti-panic function, backset 35 mm, front plate 24 x 6 mm, L = 1760 mm</p> <p>Befestigungs-Set 957324 separat bestellen. <i>Commander séparément le kit de fixation 957324.</i> Order fastening set 957324 separately.</p>	<p>1 Stk. / pce</p>	<p>906444</p>
	<p>Verlängerung für Mehrfachverriegelung RC3, Stulp 24 x 6 mm, L = 350 mm <i>Extension pour serrure multipoint, CR3, tête 24 x 6 mm, L = 350 mm</i> Extension for multiple lock RC3, front plate 24 x 6 mm, L = 350 mm</p> <p>Befestigungs-Set 957325 separat bestellen. <i>Commander séparément le kit 957325.</i> Order fastening set 957325 separately.</p>	<p>1 Stk. / pce</p>	<p>906484</p>
	<p>Schliessblech zu Hauptschloss Mehrfachverriegelung RC3, DIN links/rechts <i>Gâche pour serrure principale, verrouillage multiple CR3, DIN gauche/droite</i> Keep for main lock of multipoint locking RC3, DIN left/right</p>	<p>1 Stk. / pce</p>	<p>907094</p>
	<p>Schliessblech für Nebenschloss Mehrfachverriegelung RC3, DIN links/rechts <i>Gâche pour serrure secondaire, verrouillage multiple CR3, DIN gauche/droite</i> Keep for auxiliary lock of multipoint locking RC3, DIN left/right</p>	<p>1 Stk. / pce</p>	<p>907095</p>

Systemübersicht

Aperçu du système

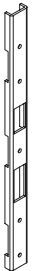

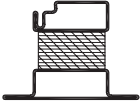
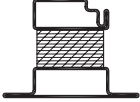
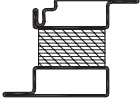
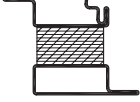
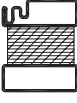
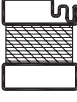





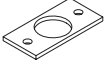
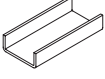

System overview

Abbildung Figure Figure	Bezeichnung Désignation Designation	Verkaufseinheit Unité de vente Sales unit	Art. Nr. art. no. art. no.
	Einschweisblech zur Befestigung Schliessblech zu Hauptschloss RC3, DIN links/rechts, verzinkt <i>Plaque à souder pour fixation de la gâche de serrure principale CR3, DIN gauche/droite, galvanisée</i> Weld-in plate for fixing the main lock keep RC3, DIN left/right, galvanized	1 Stk. / pce	957050
	Einschweisblech zur Befestigung Schliessblech für Nebenschloss RC3, DIN links/rechts, verzinkt <i>Plaque à souder pour fixation de la gâche de serrure secondaire CR3, DIN gauche/droite, galvanisée</i> Weld-in plate for fixing the auxiliary lock keep RC3, DIN left/right, galvanized	1 Stk. / pce	957051
	Vorgerichtetes Profil für Gehflügel, aus 735.803, EI30, RC3, ZM, L=2750 mm, DIN rechts <i>Profilé préentaillé pour vantail de service, 735.803, EI30, CR3, ZM, L=2750 mm, DIN droite</i> Prepared profile for active leaf, of 735.803, EI30, RC3, ZM, L=2750 mm, DIN right Edelstahl auf Anfrage / <i>Acier inox sur demande</i> / Stainless steel on request	1 Stk. / pce	953202
	Vorgerichtetes Profil für Gehflügel, aus 735.803, EI30, RC3, ZM, L=2750 mm, DIN links <i>Profilé préentaillé pour vantail de service, 735.803, EI30, CR3, ZM, L=2750 mm, DIN gauche</i> Prepared profile for active leaf, of 735.803, EI30, RC3, ZM, L=2750 mm, DIN left Edelstahl auf Anfrage / <i>Acier inox sur demande</i> / Stainless steel on request	1 Stk. / pce	953203
	Vorgerichtetes Profil für Gehflügel, aus 735.805, EI30, RC3, ZM, L=2750 mm, DIN rechts <i>Profilé préentaillé pour vantail de service, 735.805, EI30, CR3, ZM, L=2750 mm, DIN droite</i> Prepared profile for active leaf, of 735.805, EI30, RC3, ZM, L=2750 mm, DIN right Edelstahl auf Anfrage / <i>Acier inox sur demande</i> / Stainless steel on request	1 Stk. / pce	953204
	Vorgerichtetes Profil für Gehflügel, aus 735.805, EI30, RC3, ZM, L=2750 mm, DIN links <i>Profilé préentaillé pour vantail de service, 735.805, EI30, CR3, ZM, L=2750 mm, DIN gauche</i> Prepared profile for active leaf, of 735.805, EI30, RC3, ZM, L=2750 mm, DIN left Edelstahl auf Anfrage / <i>Acier inox sur demande</i> / Stainless steel on request	1 Stk. / pce	953205
	Vorgerichtetes Profil für Gehflügel, aus 735.906, EI30, RC3, ZM, L=2750 mm, DIN rechts <i>Profilé préentaillé pour vantail de service, 735.906, EI30, CR3, ZM, L=2750 mm, DIN droite</i> Prepared profile for active leaf, of 735.906, EI30, RC3, ZM, L=2750 mm, DIN right	1 Stk. / pce	953210*
	Vorgerichtetes Profil für Gehflügel, aus 735.906, EI30, RC3, ZM, L=2750 mm, DIN links <i>Profilé préentaillé pour vantail de service, 735.906, EI30, CR3, ZM, L=2750 mm, DIN gauche</i> Prepared profile for active leaf, of 735.906, EI30, RC3, ZM, L=2750 mm, DIN left	1 Stk. / pce	953211*

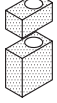
Systemübersicht

Aperçu du système

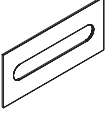





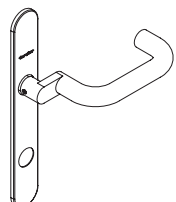
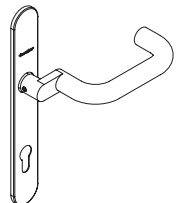
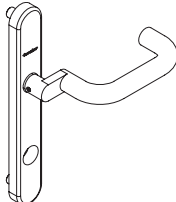
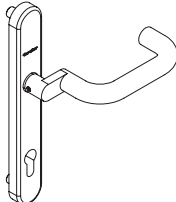

System overview

Abbildung Figure Figure	Bezeichnung Désignation Designation	Verkaufseinheit Unité de vente Sales unit	Art. Nr. art. no. art. no.
	Falztreibriegel, selbstverriegelnd, DM 35 mm, Stulp CrNi <i>Crémone à levier automatique, dist. au canon 35 mm, tête inox</i> Self-locking drive bolt lock, backset 35 mm, front plate CrNi	1 Stk. / pce	987456
	Stangenführung unten, inklusive Befestigungsschrauben <i>Guide de tringle de verrouillage basse, avec vis de fixation</i> Rod guide low, including fastening screws	1 Stk. / pce	957065
	Einschweissplatte <i>Plaque à souder</i> Weld-in plate	1 Stk. / pce	957069
	Einschweissblech für Sicherung Schlosskasten RC3 <i>Plaque à souder pour sécuriser le coffre de serrure CR3</i> Weld-in plate for securing lock casing RC3	5 Stk. / pcs	956020
	Stangenaufsatz mit Führung, RC3, für Falztreibriegel <i>Attache de tringle avec guidage, CR3, pour crémone à levier</i> Rod attachment with guide, RC3, for drive bolt lock	1 Stk. / pce	907015
	Füllstück für Isolation, forster fuego light RC3 <i>Pièce de remplissage pour l'isolation, forster fuego light CR3</i> Filler piece for insulation, forster fuego light RC3	1 Stk. / pce	956310
	Set Schliessblech für verdeckt liegenden Türschliesser, Standflügel <i>Set gâche pour ferme-porte encastré, vantail semi-fixe</i> Set keep for concealed door closer, inactive leaf	1 Stk. / pce	946027
	Schliessmulde, Standflügel, inklusive Befestigungsschrauben <i>Gâche réglable, vantail semi-fixe, avec vis de fixation</i> Locking recess, fixed leaf, including fastening screws	1 Stk. / pce	957062
	Falzluftbegrenzer, Rahmen/Flügel, inklusive Befestigungsschrauben <i>Limiteur de feuillure, cadre/vantail, avec vis de fixation</i> Rebate restrictor, frame/leaf, including fastening screws	3 Stk. / pcs	957064
	Falzluftbrücke für Paneele, CrNi <i>Pont de feuillure pour panneaux, acier inox</i> Rebate bridge for panels, CrNi	50 Stk. / pcs	907009
	Kennzeichnungsschild RC3 <i>Plaque d'identification CR3</i> Marking plate RC3	1 Stk. / pce	online

Systemübersicht

Aperçu du système

System overview

Abbildung Figure Figure	Bezeichnung Désignation Designation	Verkaufseinheit Unité de vente Sales unit	Art. Nr. art. no. art. no.
	Schutzbeschlag innen, mit Drücker, RZ, RC3, links/rechts <i>Ferrement de protection, intérieur, avec poignée, CR, CR3, gauche/droite</i> Security fitting, inside, with handle, RC, RC3, left/right	1 Stk. / pce	907390
	Schutzbeschlag innen, mit Drücker, PZ, RC3, links/rechts <i>Ferrement de protection, intérieur, avec poignée, CP, CR3, gauche/droite</i> Security fitting, inside, with handle, PC, RC3, left/right	1 Stk. / pce	907391
	Schutzbeschlag aussen, mit Drücker, RZ, RC3, links/rechts <i>Ferrement de protection, extérieur, avec poignée, CR, CR3, gauche/droite</i> Security fitting, outside, with handle, RC, RC3, left/right	1 Stk. / pce	907393
	Schutzbeschlag aussen, mit Drücker, PZ, RC3, links/rechts <i>Ferrement de protection, extérieur, avec poignée, CP, CR3, gauche/droite</i> Security fitting, outside, with handle, PC, RC3, left/right	1 Stk. / pce	907394
 M8 x 70  M6 x 70  M5 x 16  M5	Befestigungs-Set für Schutzbeschlag <i>Kit de fixation pour ferrement de protection</i> Fastening set for security fitting	1 Stk. / pce	957320
 M5 x 20 (13 Stk.)  M5 x 12 (14 Stk.)	Befestigungs-Set RC3, Mehrfachverriegelung/Schliessbleche <i>Kit de fixation CR3 pour serrure à verrouillage multiple et gâches</i> Fastening set RC3 for multiple lock and keeps	1 Stk. / pce	957324
 M5 x 20 (4 Stk.)  M5 x 12 (6 Stk.)	Befestigungs-Set RC3, für Verlängerung Mehrfachverriegelung/Schliessbleche <i>Kit de fixation CR3 pour l'extension de la serrure à verrouillage multiple et gâches</i> Fastening set RC3 for multiple lock extension and keeps	1 Stk. / pce	957325

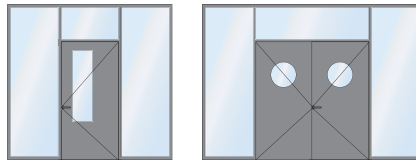
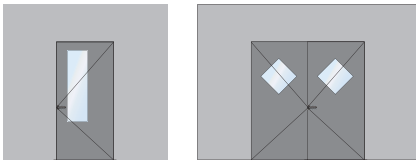
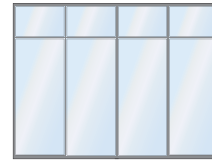
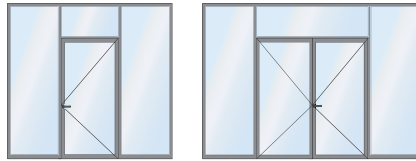
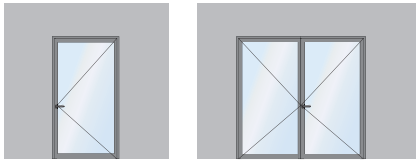
Technische Merkmale**Données techniques****Technical details****Bauarten****Variantes de construction****Construction variations**

- Tür EI30
- Verblechte Tür EI30
- Verglasung EI30 / EI60

- Porte EI30
- Porte tôleée EI30
- Cloison EI30 / EI60

- Door EI30
- Sheet metal door EI30
- Glazing EI30 / EI60

Abmessung

- 1-flüglig: lichter Durchgang
max. 1400 × 2500 mm (B × H)
- 2-flüglig: lichter Durchgang
max. 2830 × 2500 mm (B × H)
- Trennwand
Höhe: 2964 mm
Breite: unendlich

Dimensions

- 1 vantail: passage libre
max. 1400 mm × 2500 (l × h)
- 2 vantaux: passage libre
max. 2830 mm × 2500 (l × h)
- Cloison
Hauteur: 2964 mm
Largeur: illimité

Dimensions

- 1 leaf: clear passage
max. 1400 × 2500 mm (w × h)
- 2 leaves: clear passage
max. 2830 × 2500 mm (w × h)
- Partition
Height: 2964 mm
Width: unlimited

Verglasung / Paneele

- Pilkington Pyrostop
EI30: 30-18 P5A
EI60: 60-181 P5A
- Vetrotech Contraflam
EI30: 30-2 P5A
- Paneele EI30
2 × 15 mm GKF
- Paneele EI60
2 × 15 mm Gifaboard

Cloisons / panneaux

- Pilkington Pyrostop
EI30: 30-18 P5A
EI60: 60-181 P5A
- Vetrotech Contraflam
EI30: 30-2 P5A
- Panneaux EI30
2 × 15 mm GKF
- Panneaux EI60
2 × 15 mm Gifaboard

Glazings / panels

- Pilkington Pyrostop
EI30: 30-18 P5A
EI60: 60-181 P5A
- Vetrotech Contraflam
EI30: 30-2 P5A
- Panels EI30
2 × 15 mm GKF
- Panels EI60
2 × 15 mm Gifaboard

Alle Kombinationen als Brand- und Rauchschutztür geprüft!**Toutes les combinaisons de portes coupe-feu / pare-flammes sont testées!****All combinations, such as fire/ smoke protection doors are tested.****Prüfungen**

- Brandschutznachweis EN 1634-1
- Einbruchhemmung EN 1627-1630
- Dauerfunktion EN 1191

Performances

- Attestation de protection incendie selon EN 1634-1
- Résistance à l'effractions selon EN 1627-1630
- Résistance à l'ouverture et fermeture répétées selon EN 1191

Performance specifications

- Fire-resistance according to EN 1634-1
- Burglar-resistance according to EN 1627-1630
- Resistance to repeated opening and closing according to EN 1191

Zulassungen

- Erweiterungen beantragt

Homologations

- Extensions commandées

Approvals

- Approval extension submitted

Download:

- [Produktvideo](#)
- [Verarbeitung](#)

Téléchargez:

- [Video](#)
- [Mise en oeuvre](#)

Download:

- [Product video](#)
- [Processing](#)