

2024

Inspiring
profiles



forster

Contents

Editorial	5
How can you find a building-specific solution?	6
forster presto xs	
Doors and fixed glazing	10
Hinges	12
forster unico xs	
Thermally insulated doors and fixed glazing	14
Thermally insulated windows and fixed glazing	16
forster unico	
Thermally insulated fire resistant doors and fixed glazing	18
Thermally insulated fire resistant windows and fixed glazing	20
forster omnia	
Thermally insulated doors with fire protection and burglary resistance	22
Thermally insulated windows and fixed glazing	24
Sustainability is a matter of conviction for us	
How are we making our branch more sustainable?	26
Q&A with Willi Lüchinger (CEO), Luca Carlet (Head of Purchasing) and Dr. Holger Basche (CTO)	30
forster fuego light	
Telescopic fire protection sliding doors	32
Fire and smoke protection sliding doors	34
Bullet-proof fire resistant doors	36
Flush glass panels	38
Butt-joint glazing for fire protection	40
forster presto, unico and fuego light	
System-independent, burglar-resistant solutions up to RC3 with anti-panic function	42
forster presto, unico and fuego light	
Lock series 200	44
forster thermfix vario	
Curtain walls for security applications	46
forster thermfix vario Hi	
Highly thermally insulated curtain walls	48

Project: Théâtre de Carouge and Salle des Fêtes in Carouge, Canton of Geneva, Switzerland

Product: Thermally insulated doors, fixed glazing and facade elements forster unico
Interior fire doors and fixed glazing forster fuego light EI30
Doors and fixed glazing with forster presto E30

Architecture: PONT12 Architectes SA, Chavannes-près-Renens, Switzerland

Metal fabrication: AAV Contractors SA, Plan-les-Ouates, Switzerland

Client: Municipality of Carouge, Canton of Geneva, Switzerland



*Théâtre de Carouge, Switzerland
Images: Damian Poffet*

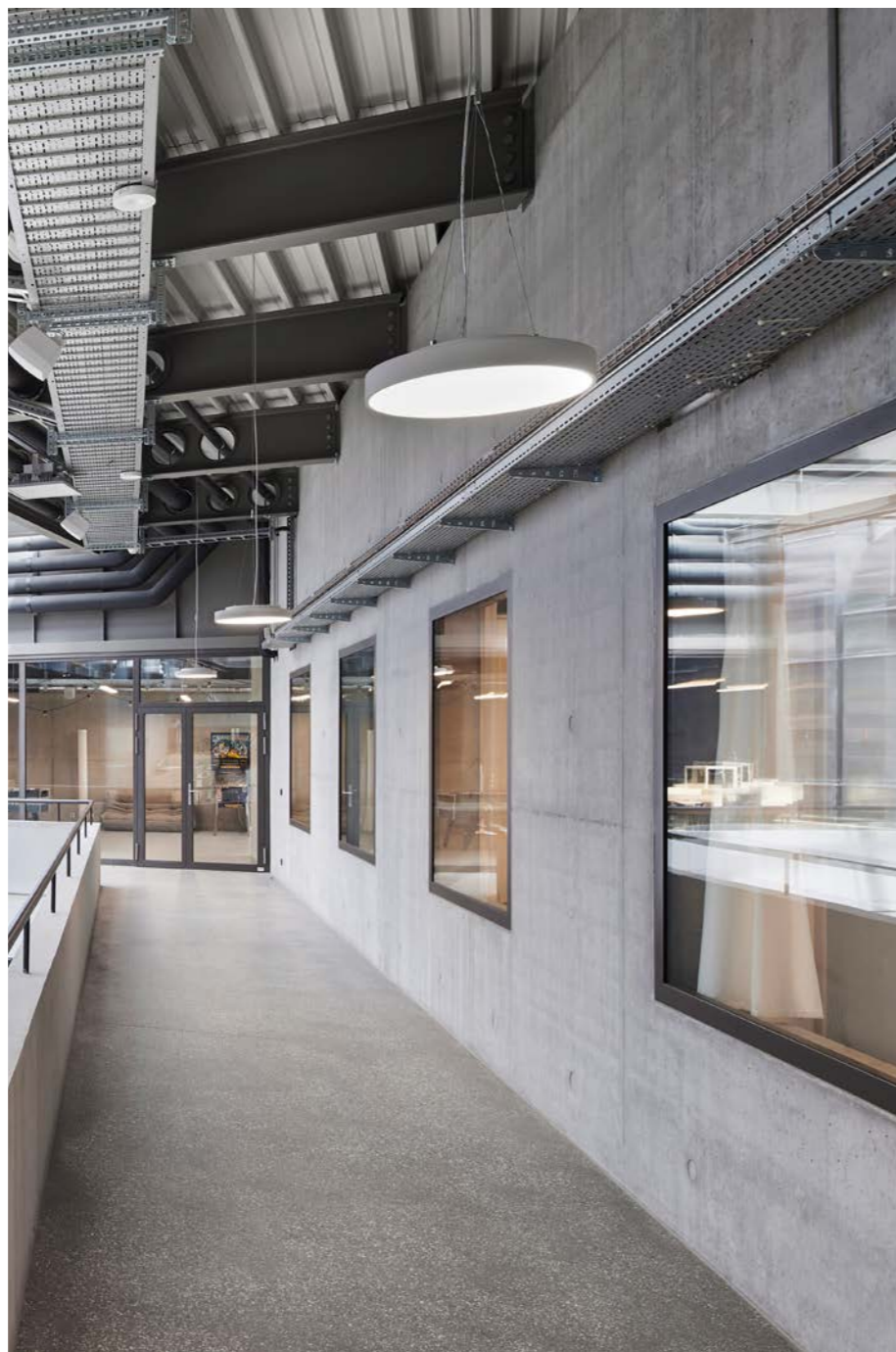

Editorial

How do we create living spaces that are in harmony with people's needs? This question is always our top priority when it comes to developing solutions for future-oriented architecture. It's always worth thinking outside the box. Theatre, for example, offers an astonishing number of answers to this question – after all, it constantly creates completely different worlds which are coherent and inspiring. Changeability, flexibility and technology are among the challenges that we also have to face in sustainable architectural projects. Just like in the theatre, the key to success is ensuring that all the protagonists interact with one another optimally.

We will give you a look behind the scenes of the “Théâtre de Carouge” to show you how this can be achieved. After all, this project is a good example of how a successful symbiosis of renovations and a new building can create a traditional cultural complex with a vision for the future. Even though we want this future to last forever, the Forster profiles used are made from 100% steel and can be recycled without any loss of quality, even after dismantling.

However, this is just one component of our understanding of sustainability – after all, we have set ourselves the goal of being completely carbon neutral by 2035. We are aware that the construction industry, and in particular the steel-processing industry, can and must play an essential role here. What we at Forster are doing to achieve this and what we are planning for the future can be found in our Q&A on pages 30 and 31, which addresses important questions.

We are particularly pleased to see that architects around the world rely on steel as a sustainability factor in their projects, just like we do. We would therefore like to present you a selection of the latest developments that use our systems in very different applications. On that note, “Curtain up!” – we hope you are meaningfully and sustainably inspired.

Best regards
Willi Lüchinger
and the Forster team

A cultural complex that combines old and new

Built in 1972, the venue “Théâtre de Carouge” was no longer able to meet current technical and legal requirements after a good 50 years, prompting the city to plan a new building. Designed by Pont12 Architectes, the new building now makes a real impact with its concept based on a series of stacked cubes and, with its clinker facades, represents a contemporary reference to the historical development of the surrounding area. The neighbouring, renovated function hall with its characteristic tented roof was connected via a common forecourt – as a link between old and new, while at the same time creating a prestigious entrance to the buildings.

Transparent transition between indoors and outdoors

The new theatre building's appearance is characterised by the harmonious combination of minerality and transparency. The targeted use of glass surfaces creates a seamless transition between the interior of the theatre and the public outdoor space. Floor-to-ceiling, continuous fixed glazing and doors with forster unico open up the building to the forecourt on the ground floor. They also ensure perfect heat insulation and acoustic performance. The slim steel profiles blend in perfectly thanks to the dark brown thermal paint. This paint also gives the whole thing an elegant and delicate aesthetic.

Top safety thanks to fire resistant doors and fixed glazing

To ensure perfect partitioning in fire zones, the architects and safety officers opted for fire resistant doors and fixed glazing with forster fuego light EI30. These fully glazed, unsupported elements ensure a safe connection between the workshops with increased fire risk and the various rooms and foyer of the new building. The forster presto E30 system also offers protection on escape routes and emphasises the transparency and openness of the interior design thanks to the fine glazing.

Variety in steel. For sustainable architecture.

Steel is close to our hearts, as like almost no other material, it combines elegance and strength, long service life and timeless design. Around 3,000 kilometres of Forster steel profiles leave our factory in Switzerland each year to be used in projects around the world. From pioneering new buildings to refurbished existing buildings – our systems play a role in ensuring contemporary, safe and sustainable architecture in every project.

No matter whether it's doors, windows or facades – Forster systems made from 100% steel and stainless steel provide a versatile toolbox. Our expert team of project consultants and trained technicians will support you right from the planning stage to project implementation. We work together with you to find the right solution from our range or advise you on customised development and production of complex special solutions.



WiSo Building, University of Cologne, Germany
Box window with integrated daylight control – forster unico HI
Images: Jens Kirchner



Saint-Omer railway station, France
Doors and windows – forster unico xs
Images: Cécile Septet – Richez Associés

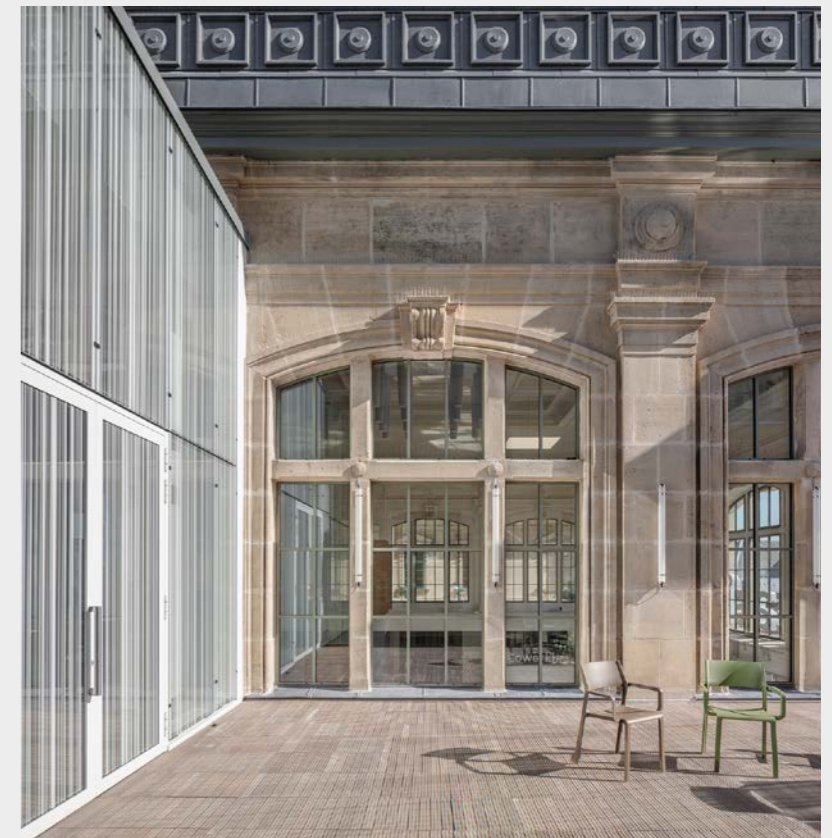



SuperHub Meerstad, Netherlands
 Thermally insulated curtain wall – forster thermfix vario
 Thermally insulated double-leaf doors – forster unico
 Image: Ronald Tilleman



Maison de la Paix, Geneva, Switzerland
 Single and double-leaf fire resistant doors – forster fuego light EI230
 Glass elements connected with butt joints – forster fuego light EI230/EI260
 Image: Damian Poffet

United Imaging Smart Medical Campus, Shanghai, China
 Facade system – forster thermfix vario HI
 Doors – forster unico HI
 Visualisation: Architectural Design & Research Institute of TONGJI University (Group) Co., Ltd., Shanghai

Berufsbildungszentrum Dithmarschen (Dithmarschen vocational training centre), Heide, Germany
 Fire resistant doors and fire resistant fixed glazing with accident-proof requirements – forster fuego light
 Smoke protection doors – forster presto 50 & 60s
 Image: Christoph Edelhoff





100% steel



Slim profiles



Barrier-free

forster presto xs Doors and fixed glazing

Combining elegance with purism, the non-insulated forster presto xs system is suitable for the interior design of architecturally sophisticated buildings. Door and glazing elements with profile face widths from 23 mm, a wide range of glazing beads and numerous other design options are available. Thanks to the new pivot door solution, extravagant room ideas are also a possibility.

NEW: Pivot door, side-hung door with fire protection EW30/E30

Technical specifications

Material variants

Bright steel

Steel zinc magnesium

Face widths

Door leaf with frame from 45 mm

Fixed glazing from 23 mm

Dimensions

Side hung door, inside width single-leaf (W×H): max. 1200 × 2400 mm

Side hung door, inside width double-leaf (W×H): max. 2400 × 2400 mm

Pivot door, inside width (W×H): max. 2500 × 3000 mm

Fixed glazing (W×H): unlimited × max. 3000 mm

Fittings

Attached and concealed flush fittings, thermal locks*

Max. leaf weight 200 kg

System features

Design variants:

Single/double leaf, with optional sidelight and fanlight

Fixed glazing

Structural depth: 50 mm

Max. filling element thickness 24 mm

Design glazing beads in aluminium and steel

Wet and dry glazing

Performance characteristics

Barrier-free according to DIN 18040

Durability of self-closing properties:

Class 6 according to EN 12400 (200,000 cycles EN 1191)

Operating forces: Class 3 according to EN 12217

Sound insulation up to $R_w = 35$ dB according to EN ISO 140-3

Fire protection: EW30, E30 according to EN 1634-1

*Take note of the country-specific approvals and requirements

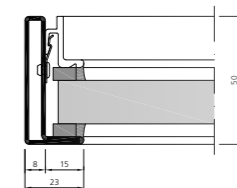
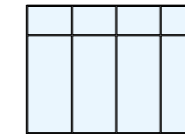
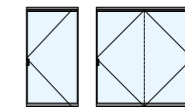
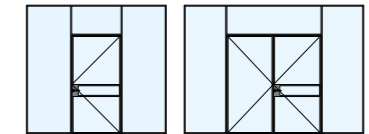
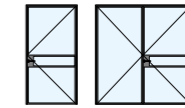

Fixed glazing

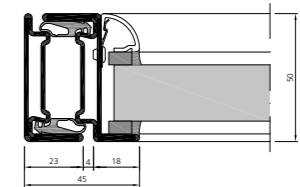

Flush door

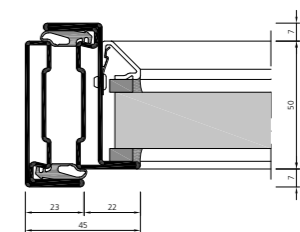

Recessed door

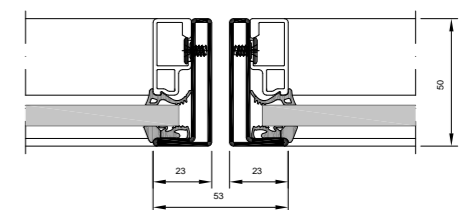

Pivot door

forster presto xs Hinges



Haus Welper, Germany
Image: Jens Kirchner

With performance combined with an uncompromising sense of form, forster presto xs has made a name for itself thanks to its extremely narrow face widths. This is also thanks to the hinges, which are installed inconspicuously on the profile and continue the slender look of the entire door design down to the finest detail. And this is all without any sacrifices being made in functionality or application – despite their low face heights and slender body, the hinges can support leaf weights of up to 100 kg. With CE marking according to EN 1935, they are ready for use in fire protection applications and in escape and emergency routes.

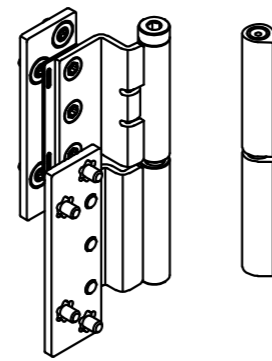

Technical specifications

Design variants

Steel weld-on hinge

Stainless steel screw-on hinge

Face height

Weld-on hinge: 90 mm

Screw-on hinge: 96.5 mm

Hinge body diameter

10 mm

System features

For flush and recessed doors

Height-adjustable (-2/+4 mm)

Lubrication nipple for simple maintenance

Performance characteristics

CE marking according to EN 1935

Durability according to EN 1191 up to 200,000 cycles

Suitable for leaf weights of up to 100 kg

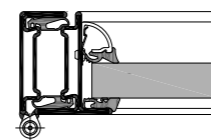

Flush weld-on hinge

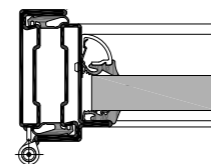

Recessed weld-on hinge

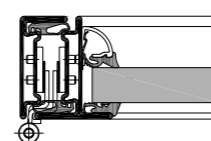

Flush screw-on hinge

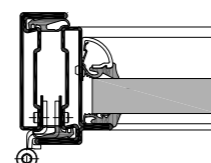

Recessed screw-on hinge





forster unico xs Thermally insulated doors and fixed glazing

Flush on both sides and with particularly narrow face widths from 23 mm, forster unico xs doors not only offer the narrowest door design in our entire portfolio, they are also an important addition for architects and planners and allow building shells to now be constructed in a uniform design. The main principle of the design is to bring a lot of light into the building interior and to improve aesthetics and spatial well-being. As the system profiles are made from 100% steel, they can also be bent freely and installed according to architectural demands. As a result, even arches in historic buildings can be equipped with adaptable steel elements.

NEW: Door with narrow face width

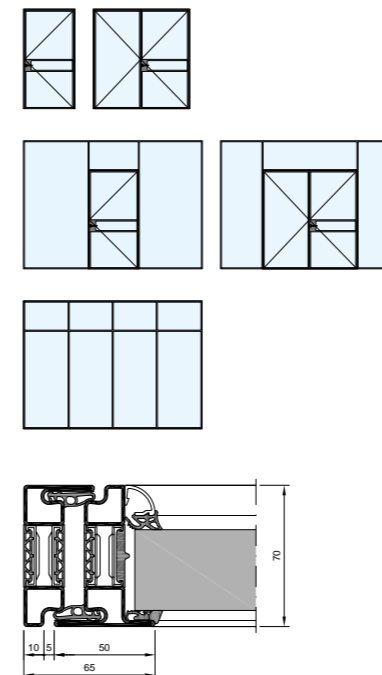

Door leaf frame

Technical specifications

Material variants

Steel zinc magnesium

Face widths

Door leaf with frame from 65 mm

Fixed glazing from 23 mm

Dimensions

Side hung door, inside width single-leaf (W×H): max. 1200 × 2400 mm

Side hung door, inside width double-leaf (W×H): max. 2400 × 2400 mm

Fixed glazing (W×H): unlimited × max. 3000 mm

Fittings

Attached fittings

Max. leaf weight 160 kg

System features

Design variants:

Side hung door with single/double leaf, with optional sidelight and fanlight

Fixed glazing

Insulated door threshold

Structural depth 70 mm

Design glazing beads in aluminium and steel

Wet and dry glazing

Performance characteristics

CE/UKCA marking according to EN 14351-1

Thermal insulation on door: U_D value up to 1.3 W/(m²·K)

Thermal insulation on fixed glazing: $U_w > 0.80$ W/(m²·K)

Durability of self-closing properties:

Class 6 according to EN 12400 (200,000 cycles EN 1191)

Doors for escape and emergency routes (partial and full panic system) according to EN 179 and EN 1125

Resistance to wind loads: Class B2/C2 according to EN 12210

Watertightness: Class 3A according to EN 12208

Air permeability: Class 3 according to EN 12207

Operating forces: Class 3 according to EN 12217

Barrier-free according to DIN 18040

Sound insulation up to $R_w = 46$ dB according to EN ISO 140-3

forster unico xs

Thermally insulated windows and fixed glazing

A uniquely slim profile design made from 100% steel, the forster unico xs thermally insulated window and fixed glazing system is suitable for use in renovating old or historic buildings as well as for modern buildings where an industrial look is required. Various opening variants are available as well as a wide range of applications for holding fillings up to 60 mm. This creates designs with the lowest U-values and outstanding sound insulation properties, such as Minergie windows. Historic reproduction push rod fittings will also be available in future to ensure an end result that is as close to the original as possible.

NEW: Historic reproduction fittings and French window

MINERGIE®

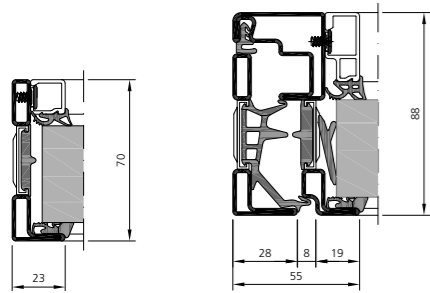

Fixed glazing

Window sash frame

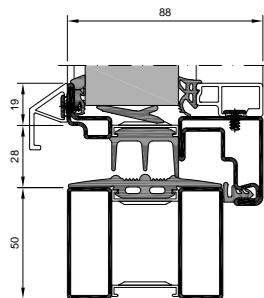

French window

Technical specifications

Material variants

Bright steel

Steel zinc magnesium

Face widths

Window sash with frame from 55 mm

Fixed glazing from 23 mm

Dimensions

Max. leaf height: 2440 mm

Max. leaf width: 1440 mm

Fixed glazing (W×H): unlimited × max. 3000 mm

Fittings

Attached and concealed flush fittings (max. opening angle 90°)

Historic reproduction fittings

Max. leaf weight 100 kg, 150 kg on request

System features

Design variants:

Opening inwards: turn/tilt and turn/tilt windows, single or double leaf

Opening outwards: turn/top-hung windows, single leaf

Fixed glazing

Optionally as a French window

Structural depth: leaf profile 88 mm, frame profile 70 mm

Max. filling element thickness 60 mm

Design glazing beads in aluminium and steel

Wet and dry glazing

Performance characteristics*

CE/UKCA marking according to EN 14351-1

Thermal insulation on window: U_w value up to 0.84 W/(m²·K)

Thermal insulation on fixed glazing: U_w value up to 0.80 W/(m²·K)

Mechanical load: Class 2 according to EN 12400 (10,000 cycles EN 1191)

Burglary resistance: RC2 according to EN 1627

Resistance to wind loads: Class B5/C5 according to EN 12210

Watertightness: Class E1050 according to EN 12208

Air permeability: Class 4 according to EN 12207

Operating forces: Class 2 according to EN 13115

Sound insulation up to $R_w = 47$ dB according to EN ISO 140-3

Take note of the country-specific approvals and requirements

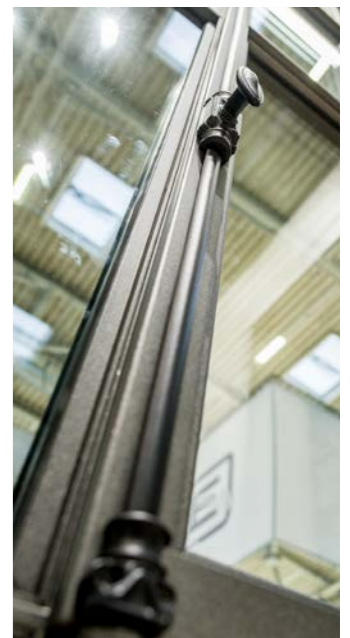
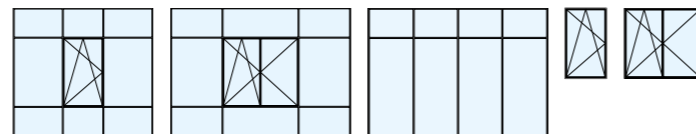



forster unico

Thermally insulated fire resistant doors and fixed glazing

The forster unico system for outdoor thermally insulated doors has EI₂₃₀ certification for fire protection and meets the requirements of EN 1634-1. Multi-point locks tailored to the system allow for efficient manufacturing. Moreover, an anti-panic emergency door is also possible.

NEW: Sheet metal fire resistant door up to EI₂₃₀ for outdoor applications

Technical specifications

Material variants
 Steel zinc magnesium
 Brushed stainless steel

Face widths
 Door leaf with frame from 110 mm
 Fixed glazing from 50 mm

Dimensions
 Side hung door, inside width single-leaf (W×H): max. 1370 × 3010 mm
 Side hung door, inside width double-leaf (W×H): max. 2700 × 2850 mm
 Fixed glazing (W×H): unlimited × max. 5000 mm

Fittings
 Attached and concealed flush fittings
 Max. leaf weight 410 kg

System features
 Design variants:
 Side hung doors with single/double leaf, with optional sidelight and fanlight
 Fixed glazing
 Insulated door threshold
 Structural depth 70 mm
 Max. filling element thickness 56 mm
 Steel glazing beads
 Wet and dry glazing

Performance characteristics*
 CE/UKCA marking according to EN 16034 and 14351-1
 Thermal insulation on door: U_b value up to 1.2 W/(m²·K)
 Thermal insulation on fixed glazing: U_b value up to 1.0 W/(m²·K)
 Fire protection: EI₂₃₀, EW30, E30 according to EN 1634-1
 Smoke protection: S_a or S₂₀₀ according to EN 1634-3
 Durability of self-closing properties: Class 8 according to EN 12400 (tested up to 1 million cycles according to EN 1191)
 Doors for escape and emergency routes (partial and full panic system) according to EN 179 and EN 1125
 Resistance to wind loads: Class B3/C3 according to EN 12210
 Watertightness: Class 3A according to EN 12208
 Air permeability: Class 4 according to EN 12207
 Impact resistance: Class 1 according to EN 13049
 Operating forces: Class 3 according to EN 12217
 Barrier-free according to DIN 18040
 Sound insulation up to R_w = 46 dB according to EN ISO 140-3

* Take note of the country-specific approvals and requirements

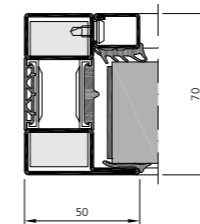
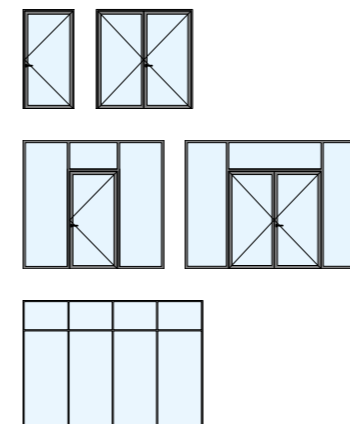

Fixed glazing

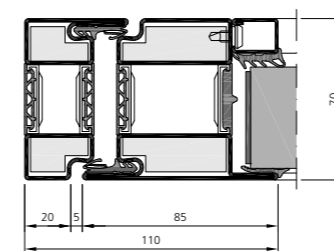

Door leaf frame

forster unico

Thermally insulated fire resistant windows and fixed glazing

Providing adequate fire protection, the forster unico thermally insulated window system rounds off the existing door and fixed glazing solution with another efficient fire protection element for outdoor use. The fire protection classes EI₂30, EI₁30, EW30 and E30 are available. The windows are based on the profiles found in the standard version, but also come with added coolants and specially designed seals to comply with the EI fire resistance classes. Fittings and accessories are available for single-leaf and double-leaf turn/turn and tilt windows.

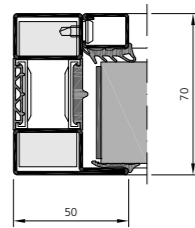
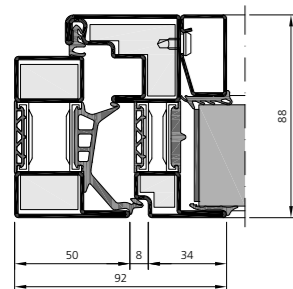
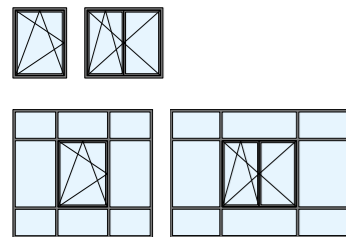

Window sash frame

Fixed glazing



Technical specifications

Material variants

Steel zinc magnesium
Brushed stainless steel**

Face widths

Window sash with frame from 92 mm
Fixed glazing from 50 mm

Dimensions

Max. leaf height: 2440 mm
Max. leaf width: 1440 mm

Fittings

Concealed flush fittings (max. opening angle 90°)
Max. leaf weight 150 kg

System features

Design variants:
Opening inwards: turn/tilt and turn windows, single/double leaf, with optional sidelight and fanlight
Fixed glazing
Window can only be opened for cleaning and maintenance work, not approved as ventilation leaves
Structural depth: leaf profile 88 mm, frame profile 70 mm
Max. filling element thickness 60 mm
Steel glazing beads
Wet and dry glazing

Performance characteristics*

CE/UKCA marking according to EN 16034 and 14351-1
Thermal insulation on window: U_w value up to 1.0 W/(m²·K)
Thermal insulation on fixed glazing: U_w value up to 1.0 W/(m²·K)
Fire protection EI₂30, EI₁30, EW30, E30 according to EN 1634-1
Mechanical load:
Class 2 according to EN 12400 (10,000 cycles according to EN 1191)
Resistance to wind loads: Class B5/C5 according to EN 12210
Watertightness: Class E1050 according to EN 12208
Air permeability: Class 4 according to EN 12207
Impact resistance: Class 3 according to EN 13049
Operating forces: Class 1 according to EN 13115
Sound insulation up to R_w = 48 dB according to EN ISO 140-3

* Take note of the country-specific approvals and requirements

** On request

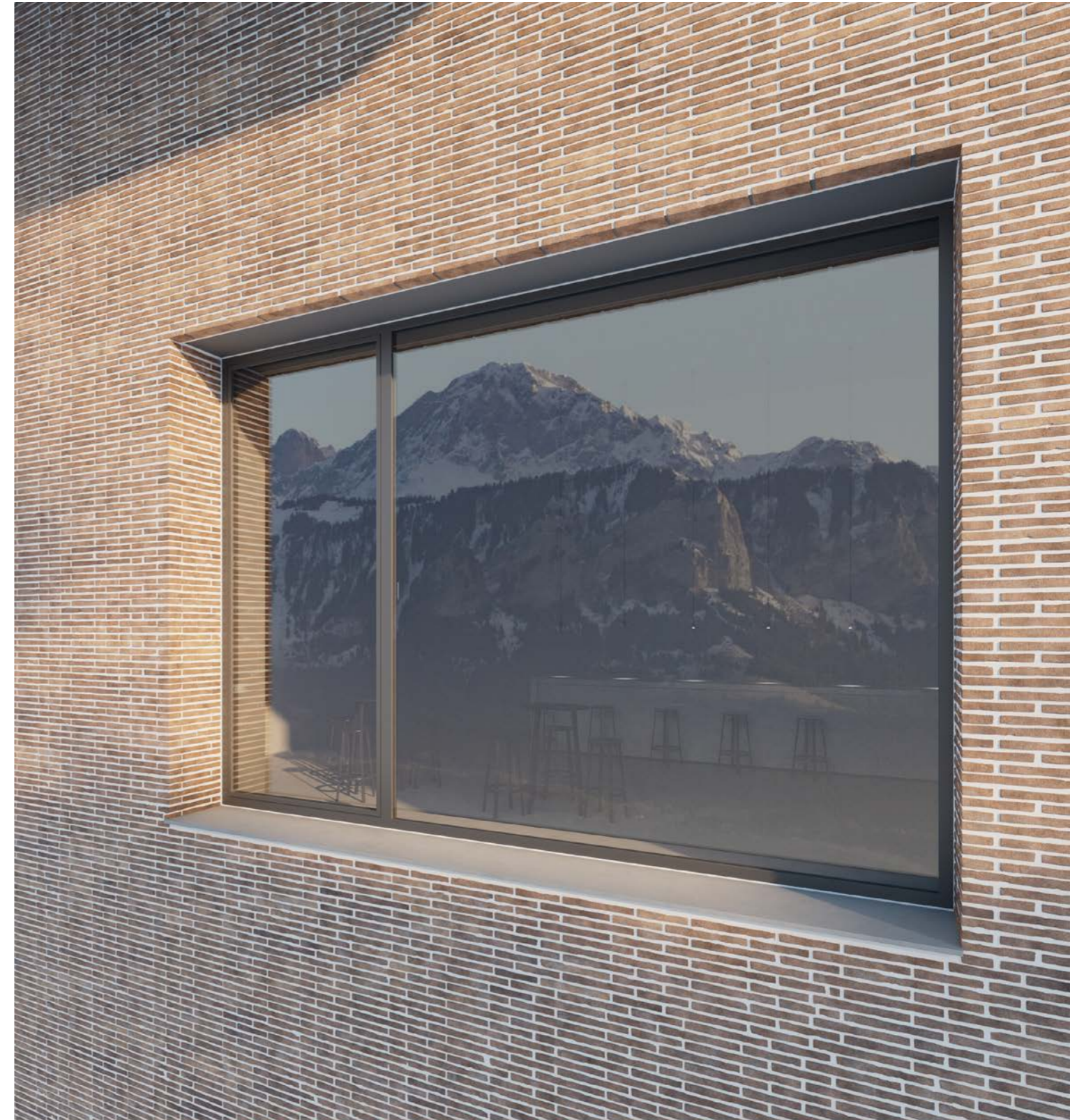



forster omnia

Thermally insulated doors with fire protection and burglary resistance

Featuring a patented construction design, the forster omnia door profile system allows customised, modular solutions to be created for outdoor use. A single profile system is enough for numerous implementations. Where required, the thermally insulated door elements can be combined with safety functions such as Class E1230 fire protection and RC2 burglary resistance. The unique construction design for multiple applications reduces planning complexity. It also means that fewer stock materials are needed and allows for simple processing and a uniform appearance of the door elements throughout the entire building. The slim profiles are made from 100% steel and do not require any additional synthetic insulating materials or coolants for fire protection.

Technical specifications

Material variants

Steel zinc magnesium

Bright steel**

Face widths

Door leaf with frame from 110 mm

Fixed glazing from 50 mm

Dimensions

Inside width single-leaf (W×H): max. 1360 × 2691 mm

Inside width double-leaf (W×H): max. 2670 × 2691 mm

Fittings

Attached and concealed flush fittings

Max. leaf weight 420 kg

System features

Design variants:

Side hung door with single/double leaf, with optional sidelight and fanlight

Fixed glazing

Insulated door threshold, simple lock installation via insertion strips

Structural depth 85 mm

Max. filling element thickness 59 mm

Steel glazing beads

Dry glazing

Performance characteristics*

CE/UKCA marking according to EN 16034 and 14351-1

U_D value up to 1.0 W/(m²·K)

Fire protection: E1230 according to EN 1634-1

Smoke protection: S₀ or S₂₀₀ according to EN 1634-3

Durability of self-closing properties: Class 8 according to EN 12400 (tested up to 1 million cycles according to EN 1191 with automatic door opener)

Doors for escape and emergency routes (partial and full panic system) according to EN 179 and EN 1125

Burglary resistance: RC2 according to EN 1627

Resistance to wind loads: Class B4/C4 according to EN 12210

Watertightness: Class 3A according to EN 12208

Air permeability: Class 4 according to EN 12207

Impact resistance: Class 4 according to EN 13049

Operating forces: Class 5 according to EN 12217

Barrier-free according to DIN 18040

Sound insulation up to R_w = 45 dB according to EN ISO 140-3

* Take note of the country-specific approvals and requirements

** On request

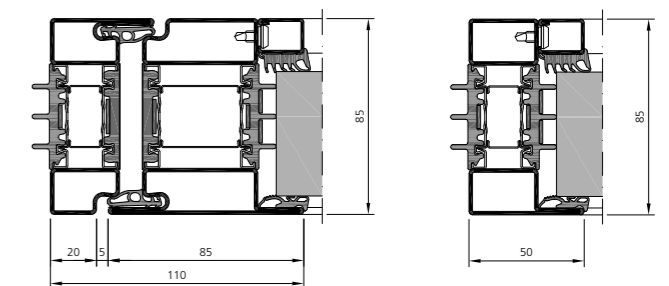
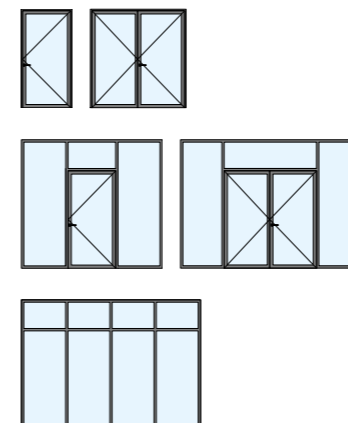

Door leaf frame

Fixed glazing

forster omnia

Thermally insulated windows and fixed glazing

In the same way as the proven door systems, the forster omnia insulated window system impresses thanks to maximum energy efficiency and durability. With U_f values of just $1.2 \text{ W}/(\text{m}^2\cdot\text{K})$, the solution contributes to a highly thermally insulated building shell and paves the way for building certification such as LEED or BREEAM. In contrast to comparable products on the market, the modular system consists entirely of the recyclable materials steel and stainless steel and dispenses with synthetic insulating materials. If cables are integrated in the profiles, their open insulator enables them to be easily removed in the event of a change of use and inserted elsewhere. In addition to sustainability qualities, forster omnia windows already have RC2 burglary resistance incorporated in their basic design, which makes it difficult to break them open with lever tools. The high structural depth of the windows (85 mm on frame side, 103 mm on sash side) allows for triple insulating glass to be combined with additional safety features.

NEW: Thermally insulated window

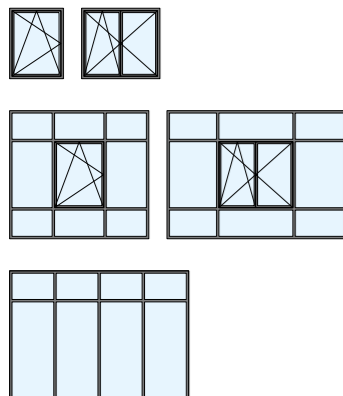

Technical specifications

Material variants

Steel zinc magnesium

Bright steel**

Brushed stainless steel**

Face widths

Window sash with frame from 92 mm

Fixed glazing from 40 mm

Dimensions

Max. leaf height: 2840 mm

Max. leaf width: 1640 mm

Fittings

Attached and concealed flush fittings

Max. leaf weight 150 kg

System features

Design variants:

Opening inwards: turn/tilt and turn/tilt windows, single or double leaf, with optional sidelight and fanlight

Fixed glazing

Structural depth: leaf profile 103 mm, frame profile 85 mm

Max. filling element thickness 69.5 mm

Glazing beads in aluminium and steel

Wet and dry glazing

Performance characteristics*

CE/UKCA marking according to EN 14351-1

Thermal insulation: U_f value up to $1.2 \text{ W}/(\text{m}^2\cdot\text{K})$

Mechanical load: Class 2 according to EN 12400 (10,000 cycles EN 1191)

Burglary resistance: RC2 according to EN 1627

Resistance to wind loads: Class B4/C4 according to EN 12210

Watertightness: Class E750 according to EN 12208

Air permeability: Class 4 according to EN 12207

Impact resistance: Class 3 according to EN 13049

Operating forces: Class 1 according to EN 13115

Sound insulation up to $R_w = 49 \text{ dB}$ according to EN ISO 140-3

* Take note of the country-specific approvals and requirements

** On request

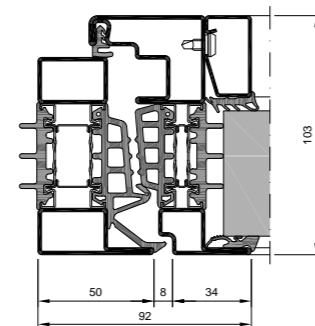

Window sash frame

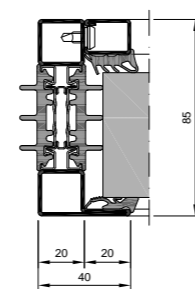

Fixed glazing



CE-marking



100% steel



Insulation



Burglar resistance

MINERGIE®



Architectural solutions with an eye on the future.

How are we making our branch more sustainable?

Joint commitment

We are in constant discussions with our key suppliers on how we can continually improve sustainability in production while taking social and economic aspects into account.

Setting a good example with rail and electric trucks

The profile components from one of our biggest suppliers are currently sent exclusively via rail to intermediate storage – and then on to us using an electric truck.

Innovations in steel with less CO₂

From mid-2024, the profiles we manufacture in house will be gradually switched to steel sheet, with at least 75 percent coming from recycled material. Only 532 kg of CO₂ equivalents are created during their production – compared to 2230 kg per tonne when using conventional steel.

A campus for tomorrow

Forster is currently constructing its new company campus – the first hybrid-use building ensemble in Switzerland to be fully LEED GOLD certified. It is equipped with the latest sustainable technologies and is ready for completely energy-neutral production.

Energy from renewable sources

From 2024, a photovoltaic system measuring 6000 square metres installed on the roofs of our new site in Romanshorn will provide our production facilities with over 100% green energy – any excess energy is fed into the regional power grid. For heating and cooling, we use heat pumps with heat recovery, operated entirely using self-generated energy.

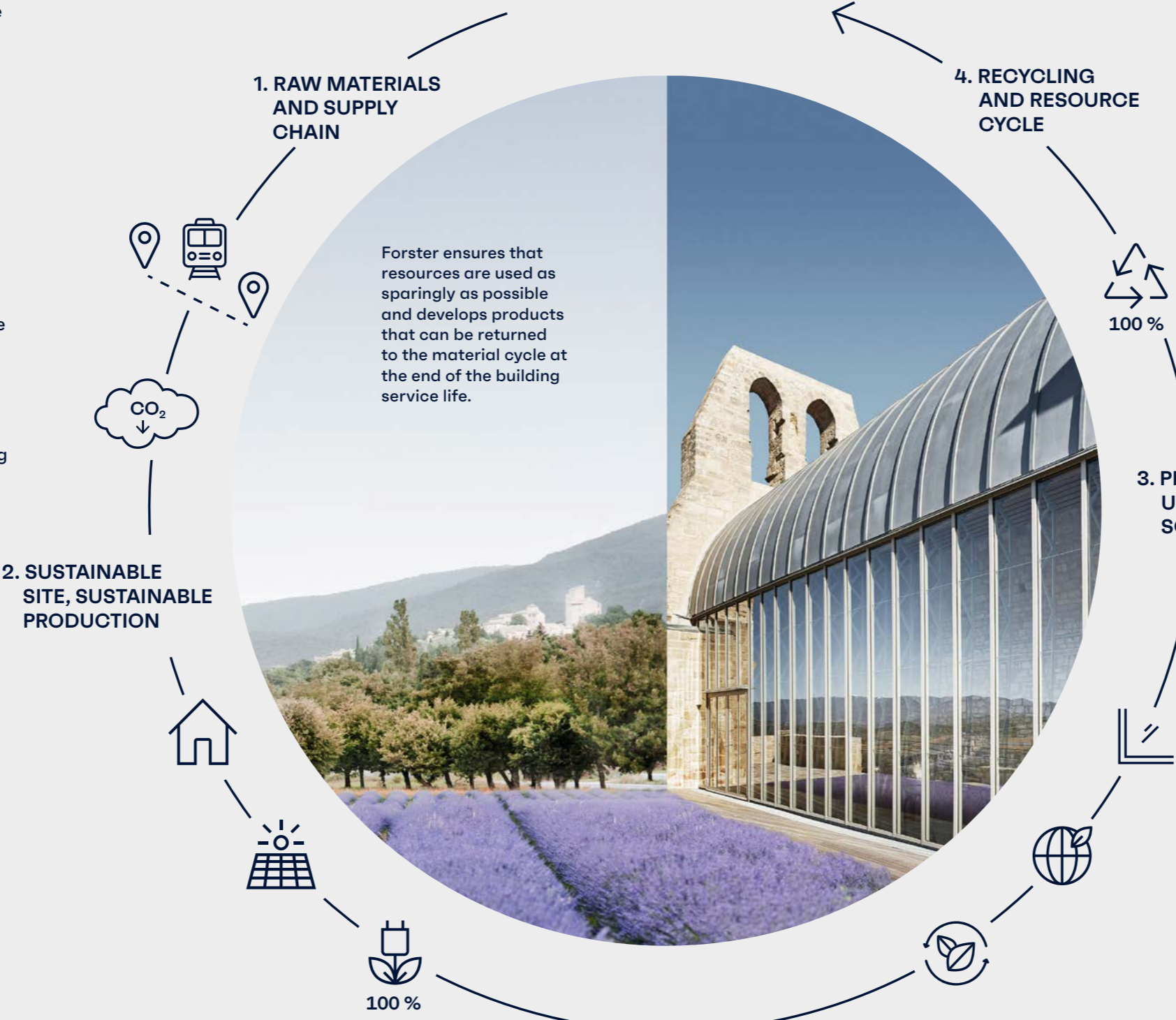

Timeless – in every way

Six of our nine product lines are made from 100% steel, meaning they are completely recyclable and can be reused without any loss in quality. You can find out more about steel and its world-class recyclability on our website:



Certified for the future

We are constantly expanding our offering of products that have been designed and manufactured according to the cradle-to-cradle principle. From the end of 2024, Forster will be providing product-specific environmental product declarations (EPD).

Less material

Thanks to their outstanding static values, our steel products require only little material.

High insulation

With our products – many of which are Minerergie and Passive House certified – buildings can achieve excellent thermal insulation values without using plastic strips or insulating cores.

A long-lasting solution

Forster systems have an above-average service life, even under heavy load.

**We are
committed
to being
carbon neutral
by 2035.**



Sustainability is a matter of conviction for us

We want to be number one in the world.

For us, being sustainable means enabling buildings to have a long life in today's fast-paced world. In our Q&A with Willi Lüchinger (CEO), Luca Carlet (Head of Purchasing) and Dr Holger Basche (CTO), you can find out how we are playing our part here at Forster and how we have already set the course for a green future.



Willi Lüchinger, CEO

«Our goal is to become carbon neutral by 2035.»

The construction industry is responsible for considerable material and energy consumption around the world. What is Forster doing to reduce this?

Willi Lüchinger: Every day, we work on reducing the environmental impact of production and distribution to an absolute minimum. This includes introducing energy-efficient technologies, increased use of renewable energies, promoting recycling and implementing sustainable supply chains. Our goal is to become carbon neutral by 2035, because sustainability is not just an obligation, but a matter of conviction for us.

How have the requirements for buildings changed in recent years and what does this mean for Forster?

Willi Lüchinger: As a matter of fact, we are seeing increased awareness of health and well-being in buildings. Attention is increasingly being paid to design aspects, the optimal use of daylight and acoustic comfort. Increasing demands are also being placed on the resili-

ence of buildings, i.e. protection against weather-related or safety-related influences. Our systems offer major advantages in all these areas. Steel doors, windows and facade elements are extremely robust. Thanks to their outstanding statics, our profiles also have particularly narrow face widths that allow as much daylight as possible into the rooms. Last but not least, our systems also impress when it comes to acoustic performance.

Forster is setting the course for the future by building a modern campus in Romanshorn. What were the reasons behind this move?

Willi Lüchinger: At our current location, we as tenants have only very limited say in internal processes, infrastructure and buildings. That's why we came to the decision that we need our own location if we want to grow sustainably, carbon neutrally and in terms of quality. In Romanshorn, we will have our own home for the first time in our history. This is something which is also extremely important for the DNA of our company. We want to become the global number one in our niche with our products and systems – the campus in Romanshorn is an important milestone in this regard.

What measures have been taken to make the new campus building as sustainable as possible?

Luca Carlet: Our high-quality products play a significant role in ensuring sustainable construction, meaning it is a matter of course for us to meet these standards in our own construction projects. Right from the start, we made it our goal to have the building complex LEED Gold certified. This makes our campus the first building complex of its kind to receive this prestigious distinction in Switzerland. LEED certification is internationally recognised and defines clear standards for environmentally friendly and resource-saving construction, but also for the organisation of construction sites, workplace design and outdoor facilities. Our project has been awarded the Gold certification, which is the highest distinction handed out. As a company that sells its products around the globe, this is certainly a good representation of what we stand for in today's world.



Luca Carlet, Head of Purchasing

«The new Forster campus will be the first building complex of its kind in Switzerland to be LEED Gold certified.»

Only green steel is used in the new building. What does that mean exactly?

Luca Carlet: This “green” steel has environmentally friendly and sustainable attributes. In contrast to conventional steel production, it is manufactured with a focus on reducing CO₂ emissions. Attention is paid to ensuring that renewable energies are used in production and that more recycled materials are used in order to reduce resource consumption. Green steel is a component of the steel industry's environmentally conscious and forward-looking approach which aims to significantly reduce the environmental footprint of the industry.

Why is steel fundamentally more sustainable than other materials?

Holger Basche: A material's sustainability is determined by various criteria. These criteria include resource consumption and energy efficiency during extraction of the material, recyclability, long service life and the environmental impact during its service life – to name just the most important. Steel has a particularly favourable ratio of cross-section to static load-bearing capacity, which is reflected in a very low material cost for given requirements. Steel is also 100% recyclable and has no negative environmental impact during its entire service life.

What role does long service life play in Forster systems?

Holger Basche: Steel can withstand very high loads. Generally speaking, wear and tear or material fatigue do not play a role in our applications. Of course, untreated, unalloyed steel will rust, but other materials such as wood or aluminium will also age quickly without adequate protection. However, today's mostly organic coatings are so good that they can last the service life of a building if properly cared for. As Forster profiles are made entirely from steel, they can even only be hot-dip galvanised, unlike systems from other manufacturers.



Dr. Holger Basche, CTO

«Steel is 100% recyclable and has no negative environmental impact during its entire service life.»

What research and development projects is Forster pursuing to further improve sustainability?

Holger Basche: Forster is pursuing various projects, including projects to develop even more energy-efficient production processes, to use environmentally friendly materials and to promote circular economy practices. These research and development efforts are an important part of Forster's sustainability strategy, not only in order to achieve our climate goal, but also, of course, to impress our customers with our products time and again.

forster fuego light

Fire and smoke protection sliding doors



Ideal for projects with special requirements, the forster fuego light fire-resistant sliding door can also be expanded with the addition of a smoke protection closure in line with EI₂₃₀ / C5 / S₂₀₀. It is equipped with sealing levels on four sides, making it the ideal solution when transparency, fire protection, increased tightness and special requirements for air pressure conditions are required. The space-saving design of the automatic door improves the flow of people and goods in passageways.

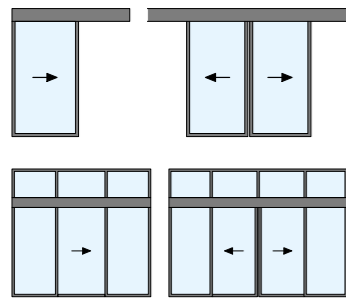

Technical specifications

Material variants

Steel zinc magnesium
Brushed stainless steel**

Face widths

Door leaf from 90 mm
Central section from 152 mm

Dimensions

Inside width single-leaf (W×H): max. 1380 × 2500 mm
Inside width double-leaf (W×H): max. 2600 × 2500 mm

Fittings

Drive systems from different manufacturers tested and approved
Max. leaf weight according to drive manufacturer
No current, self-closing (without battery buffer)

System features

Design variants:
Sliding door with single/double leaf, with optional sidelight and fanlight
Increased tightness due to four-sided sealing level around the edges
Structural depth 65 mm
Max. filling element thickness 53.5 mm
Steel glazing beads
Wet and dry glazing

Performance characteristics*

Fire protection: EI₂₃₀ according to EN 1634-1
Smoke protection: S₀ or S₂₀₀ according to EN 1634-3
Durability of self-closing properties: Class 8 according to EN 12400 (tested up to 1 million cycles according to EN 1191)
Barrier-free according to DIN 18040
Finger trapping protection according to DIN 18650/EN 16005

* Take note of the country-specific approvals and requirements

** On request

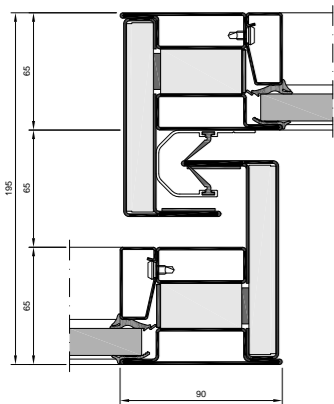

Labyrinth seal

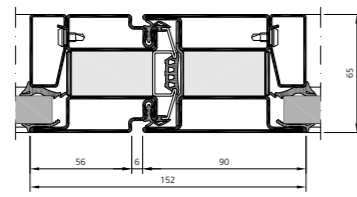

Central section of sliding leaf

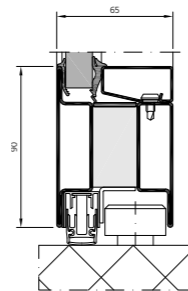

Drop seal



University Hospital Bern, Switzerland
Image: Visualista.ch



forster fuego light Bullet-proof fire resistant doors

The epitome of understatement, the forster fuego light fire-resistant door and glazing is now also available as a bullet-proof version in the FB4 NS class. Both transparent and flush sheet metal solutions are possible, thus opening up new planning freedom. The safety barrier is achieved thanks to special reinforcements in the profiles and is integrated into the slender appearance while being indistinguishable to onlookers.



University Hospital Bern, Switzerland
Image: Visualista.ch

Technical specifications

Material variants

Steel zinc magnesium
Brushed stainless steel

Face widths

Door leaf with frame from 130 mm
Fixed glazing from 70 mm

Dimensions

Inside width single-leaf (W×H): max. 1400 × 3000 mm
Inside width double-leaf (W×H): max. 2830 × 3000 mm
Fixed glazing (W×H): unlimited × max. 5000 mm

Fittings

Attached fittings
Max. leaf weight 410 kg

System features

Design variants:
Side hung door with single/double leaf, opening outwards, with optional sidelight and fanlight
Flush sheet metal door
Fixed glazing
Filling elements: glass and panels
Structural depth 65 mm
Steel glazing beads
Wet and dry glazing

Performance characteristics*

Fire protection: EI230 according to EN 1634-1
Bullet resistance: Class FB4 NS according to EN 1523
Durability of self-closing properties: Class 8 according to EN 12400 (tested up to 1 million cycles according to EN 1191 with automatic door opener)
Doors for escape and emergency routes (partial and full panic system) according to EN 179 and EN 1125
Operating forces: Class 1 according to EN 12217

* Take note of the country-specific approvals and requirements

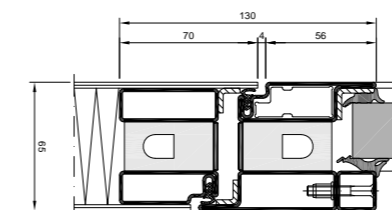
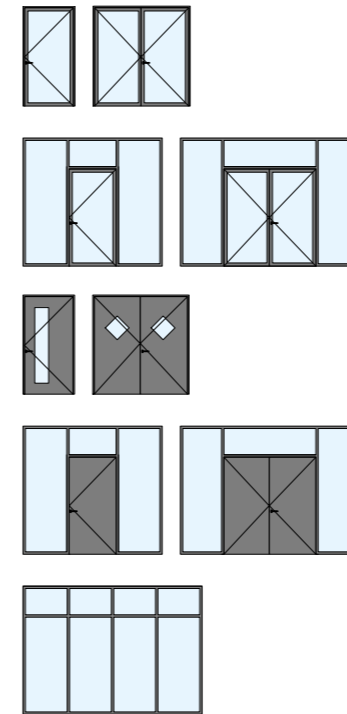

Door leaf frame

forster fuego light

Flush glass panels

Aesthetic and fireproof, the flush glass panels in the forster fuego light system feature proven EI30 or EI60 fire protection and are also an outstanding design element in large-surface glazing. The elegant, slim steel profiles allow for transparent, open room design as part of contemporary architecture.



Technical specifications

Availability

Flush glass panels from Q3 2024

Material variants

Steel zinc magnesium

Brushed stainless steel

Face widths

Fixed glazing from 50 mm

Dimensions

Inside width single-leaf (W×H): max. 1400 × 2390 mm

Inside width double-leaf (W×H): max. 2320 × 2390 mm

Fixed glazing (W×H):

EI30: unlimited × max. 5000 mm

EI60: unlimited × max. 4000 mm

System features

Design variants:

Side hung doors EI30 with single/double leaf, with optional sidelight and fanlight

Fixed glazing EI30/EI60

Patented clip system for efficient use of the glass panels

Structural depth 65 mm

Filling element thickness 63 mm

Wet glazing

Performance characteristics*

Fire protection: EI30, EI60 according to EN 1634-1

* Take note of the country-specific approvals and requirements

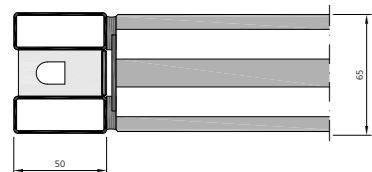
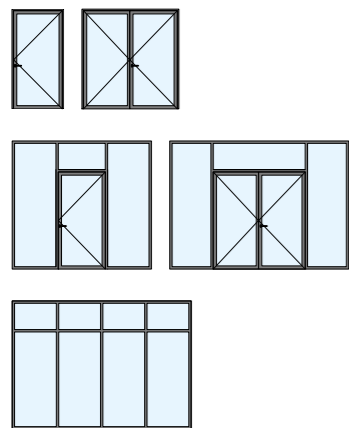

Profile with flush glass panels

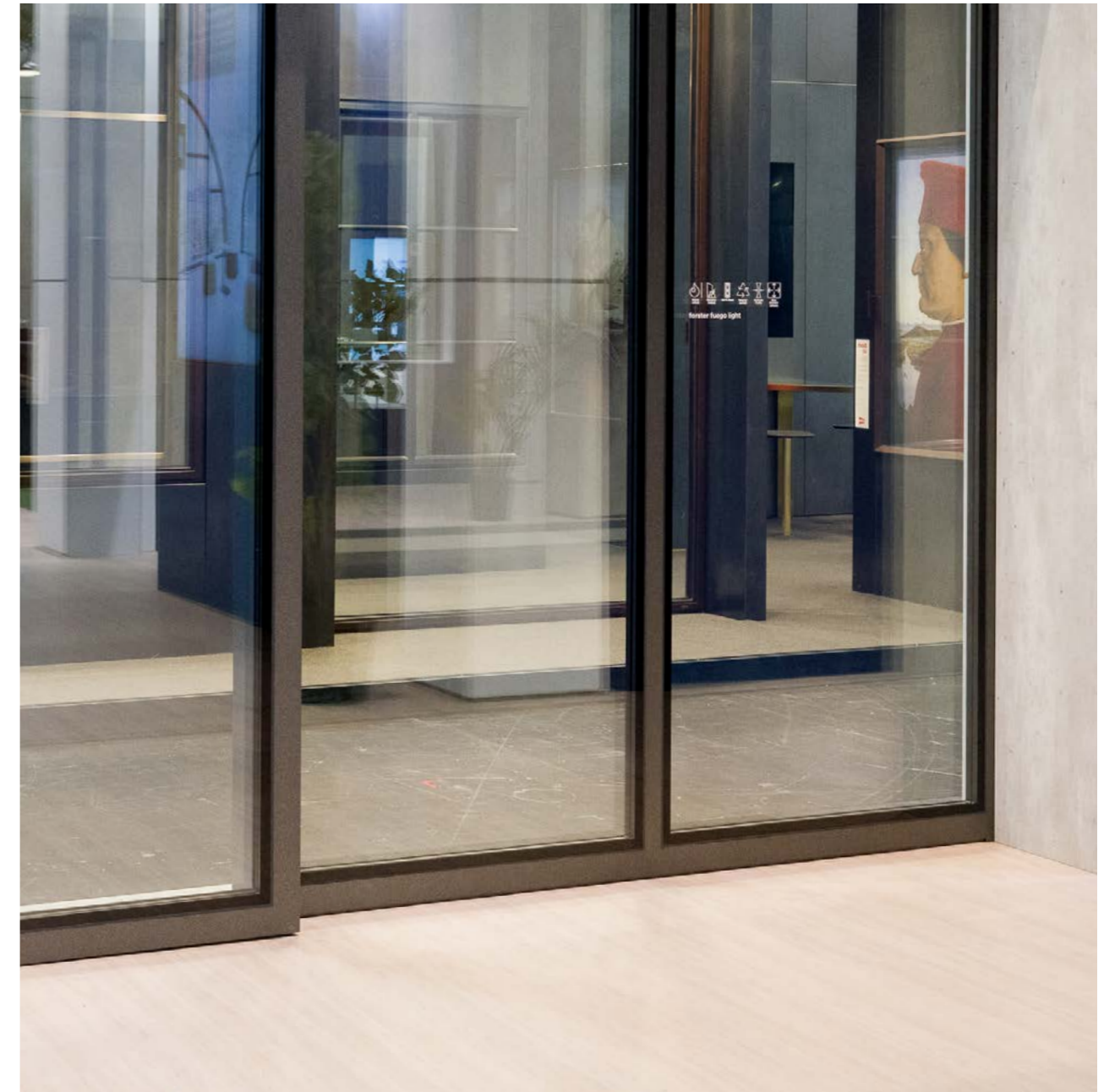

Maison de la Paix, Geneva, Switzerland
Image: Damian Poffet



forster fuego light Butt-joint glazing for fire protection

Featuring an ornate design and secure glazing, the forster fuego light butt joint glazing provides excellent views through glass surfaces that allow light to flow while also providing safety in case of fire in Class EI30 or EI60. The glass elements can be joined together with a joint of just 4 mm, resulting in a stylish, transparent glass front that is virtually uniform. The fixed glazing is installed in the floor and ceiling area using horizontal forster fuego light retaining profiles. Transoms in the vertical glass joint are not necessary thanks to this concept. The glass-on-glass connection is made at the construction site with the help of special fire-resistant sealing. The glass-on-glass joint design can also be combined with forster fuego light fire-resistant doors to ensure holistic planning.

Technical specifications

Material variants

Steel zinc magnesium
Brushed stainless steel

Face widths

Fixed glazing from 50 mm

Dimensions

Fixed glazing (W×H): unlimited × max. 4000 mm

System features

Design variants:
Fixed glazing
Installation of fire-resistant doors possible
90° to 270° corner glazing EI30 and EI60
Mono or insulating glass up to max. 3900 mm
Structural depth 65 mm
Max. filling element thickness 53.5 mm
Steel glazing beads
Wet and dry glazing

Performance characteristics*

Fire protection: EI30, EI60 according to EN 1634-1

* Take note of the country-specific approvals and requirements

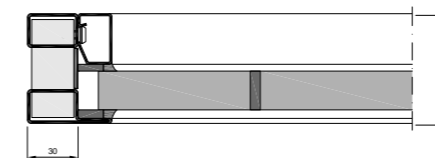
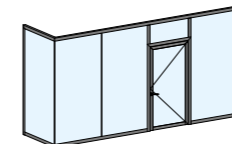
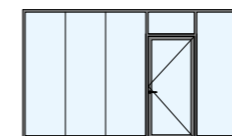

Composite butt-joint glazing

forster presto, unico and fuego light

System-independent, burglar-resistant solutions up to RC3 with anti-panic function



Porcelain Collection, Dresden, Germany

Offering multi-functional uniformity, burglar-resistant door elements are now required in a wide range of building types and applications, both outdoors and indoors. Additionally, the solutions often also have to meet additional safety requirements, such as fire protection, smoke protection or emergency exit and panic door closures. The new burglar-resistant overall solution from Forster offers this outstanding flexibility, with the right profile for every situation in combination with the compatible systems forster presto, unico and fuego light. Multifunctionality doesn't mean sacrifices have to be made in terms of appearance or service life. Typically of Forster solutions, the tested steel/glass constructions are robust, thin and aesthetically pleasing – and remain so for many years.

Technical specifications

Availability

- forster fuego light RC2 & RC3: available now
- forster presto 50 RC2: available now
- forster presto 60s RC3: available now
- forster unico RC2 & RC3: Q3/2024 (object solutions on request)

Dimensions

- Inside width single-leaf (W×H): max. 1400 × 3000 mm
- Inside width double-leaf (W×H): max. 2830 × 3000 mm
- Fixed glazing (W×H): unlimited × max. 5000 mm

Fittings and accessories

- RC2:**
- Mortise lock without additional lock up to leaf height of 2500 mm
 - With supplementary top shootbolt on leaf heights above 2500 mm
 - Clipped glazing beads
 - Glass types from P4A/P6B/P8B can be used according to EN 356
 - Attached and concealed flush door fittings
- RC3:**
- Safety multi-point lock
 - Screwed glazing beads
 - Different glass types from P5A/P8B can be used according to EN 356
 - Attached and concealed flush door fittings

System features

- Design variants:
 - Side hung door with single/double leaf, with optional sidelight and fanlight
 - Flush sheet metal door
 - Fixed glazing

Performance characteristics*

- Burglary resistance: RC2/RC3 according to EN 1627
- Fire and smoke protection according to EN 1634-1 and EN 1634-3
- Doors for escape and emergency routes (partial and full panic system) according to EN 179 and EN 1125
- Barrier-free according to DIN 18040

* Take note of the country-specific approvals and requirements

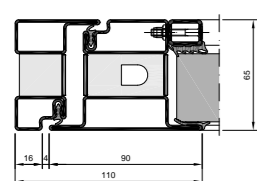
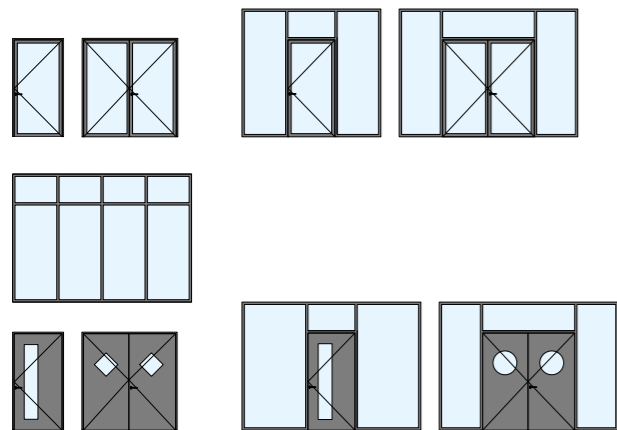

forster fuego light door leaf frame

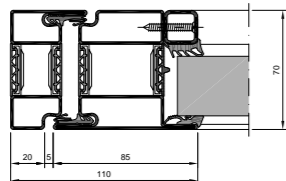

forster unico door leaf frame

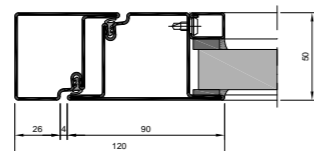

forster presto 50 door leaf frame

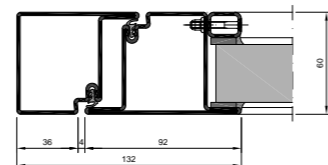

forster presto 60s door leaf frame



Maison de la Paix, Geneva, Switzerland
Image: Damian Poffet



forster presto, unico and fuego light Lock series 200

As a multi-functional addition, the lock series 200 for forster fuego light, unico and forster presto meets virtually all wishes and requirements in terms of modern, secure door technology, whether constant use, fire and smoke protection or all necessary functions for escape and emergency routes. This is in addition to self-locking and electronic handle control. Installation is simple and quick thanks to uniform dimensions, including in combination with prepared forster fuego light profiles.

Technical specifications

Basic versions

Locks without anti-panic function (incl. roller latch and latch protection)
Panic function B, D, E for single/double-leaf anti-panic doors

Extended versions

Basic versions can be expanded with the following options:
Supplementary top shootbolt
Self-locking (possible for panic functions E and B)
Monitoring
Electronic handle control (EDS), (possible for panic function B)
Latch and dead bolt retraction

Properties

All locks available in profile and round cylinders
Uniform face plate dimensions (320 × 29.5 × 3 mm)
Rotatable latch for switching between DIN left and DIN right
Adjustable escape direction
Standard version with backset 35 mm
System-compatible, matching accessories
Rod guide with adjustable spring force (three stages)
Design-oriented triggering fitting according to EN 179 and EN 1125

System features

CE marking according to DIN EN 12209

Performance characteristics

Fire resistance: EN 1634-1 up to class EI90
Smoke protection according to EN 1634-3
Durability according to EN 1191 up to 1 million cycles
Escape route: anti-panic locks suitable for single/double-leaf escape and emergency routes (partial and full panic) according to EN 179 and EN 1125

Functions also available in combination



*Théâtre de Carouge, Switzerland
Images: Damian Poffet*

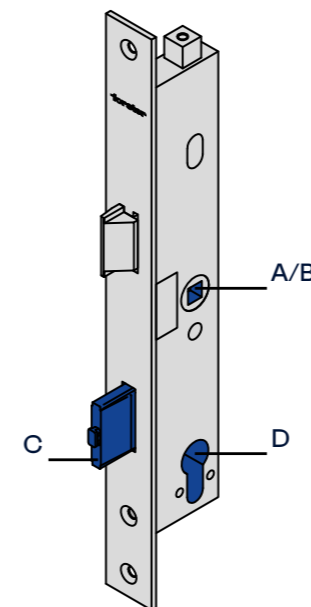

Lock monitoring functions
A: Operation of outside lever handle
B: Operation of inside lever handle
C: Dead bolt locked or unlocked
D: Cylinder actuated

forster thermfix vario

Curtain walls for security applications

With impressive dimensions and maximum safety, forster thermfix vario curtain walls meet all requirements in terms of high thermal insulation, burglary and bullet resistance, and fire protection. The corner constructions and glass-bonded panels with a size of up to 1500 x 3000 mm have been tested for fire protection and facilitate wide-ranging design and application possibilities with a consistently high level of safety. Profiles in steel or stainless steel positioned in the room are used for load bearing. Thanks to the outstanding static properties, impressive field sizes are possible despite the discreet profile face widths of just 45 mm. Seals printed with position markings guarantee safe, precise processing on site. In addition, sophisticated processing tools save time during production and assembly. Where openings are required in the curtain wall, side-hung or sliding doors from the forster fuego light system offer ideal combination possibilities.

Technical specifications

Material variants

Bright steel
Steel zinc magnesium
Steel GV/BC
Brushed stainless steel

Face widths

Mullion/transom profile in 45 and 60 mm

Dimensions

Fixed glazing (WxH): unlimited x max. 5000 mm across floors

System features

Design variants:
Curtain wall or inner partition
Corner designs in classes EI30 and EI60 up to 5000 mm floor height
Panels up to max. 1500 x 3000 mm with glass bonding possible
Easy installation thanks to mechanical T-joints
Cover strips in aluminium and stainless steel
Structural depth 50 to 150 mm
Max. filling element thickness 70 mm
Max. filling weight 500 kg
Dry glazing

Performance characteristics*

CE/UKCA marking according to EN 13830
Thermal insulation: U_f value up to 1.2 W/(m²·K)
Fire protection: EI30/EI60/EI90/E30/E60/E90/EW30/EW60 according to EN 1634-1
Fire protection 60/90/120 minutes according to UL 263 & ULC-S101
Burglary resistance: WK2/WK3 according to EN 1627
Bullet resistance:
FB4 NS according to EN 1522 as customised solution
Explosion resistance:
EPR1 (S) according to EN 13123-1 as customised solution
Resistance to wind load:
3 kN/m² according to EN 12179, safety load 4.5 kN/m²
Watertightness: Class RE1200 according to EN 12155
Air permeability: Class AE (>600) according to EN 12153
Impact resistance: Class I5/E5 according to EN 14019
Sound insulation up to $R_w = 45$ dB according to EN ISO 140-3

* Take note of the country-specific approvals and requirements

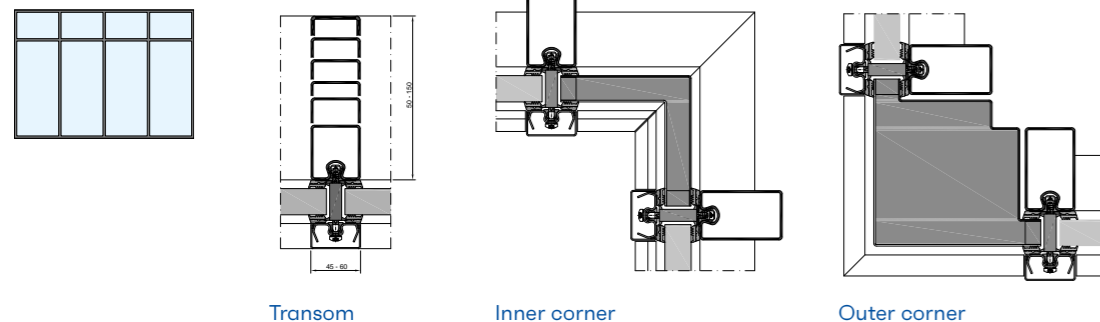

Transom

Inner corner

Outer corner

SuperHub Meerstad,
Netherlands
Image: Ronald Tilleman



United Imaging Smart Medical Campus, Shanghai, China
 Visualisation: Architectural Design & Research Institute of
 TONGJI University (Group) Co., Ltd., Shanghai

forster thermfix vario HI Highly thermally insulated curtain walls

An aesthetic masterpiece designed to meet the Passive House standard, the forster thermfix vario HI curtain wall meets the highest Passive House efficiency class phA and therefore offers excellent thermal insulation. The steel profile system can also be used to create impressive field sizes – even for very slim profiles with a width of 45 or 60 mm. Since the Passive House-certified system is based on the forster thermfix vario standard mullion/transom construction, many components can be used across systems. Burglary resistance and fire protection can be taken into account while retaining the same appearance across the entire curtain wall. To ensure similarly high insulation properties on the window and door components, the curtain wall system can be ideally combined with the forster unico, unico xs and omnia profile systems.

Technical specifications

Material variants

- Bright steel
- Steel zinc magnesium
- Steel GV/BC
- Brushed stainless steel

Face widths

- Mullion/transom profile in 45 and 60 mm

Dimensions

- Fixed glazing (W×H): unlimited × across floors, depending on static requirements

System features

- Design variants:
 - Curtain wall or inner partition
- Easy installation thanks to mechanical T-joints
- Cover strips in aluminium and stainless steel
- Structural depth 50 to 250 mm
- Max. filling element thickness 70 mm
- Max. filling weight 500 kg
- Dry glazing

Performance characteristics*

- CE/UKCA marking according to EN 13830
- Thermal insulation on mullion/transom:
 - U_f value up to 0.49 W/(m²·K), U_{ow} value up to 0.6 W/(m²·K)
- Resistance to wind loads:
 - 3 kN/m² according to EN 12179, safety load 4.5 kN/m²
- Watertightness: Class RE1350 according to EN 12155
- Air permeability: Class AE (>600) according to EN 12153
- Impact resistance: Class I5/E5 according to EN 14019
- Sound insulation up to R_w = 45 dB according to EN ISO 140-3

* Take note of the country-specific approvals and requirements

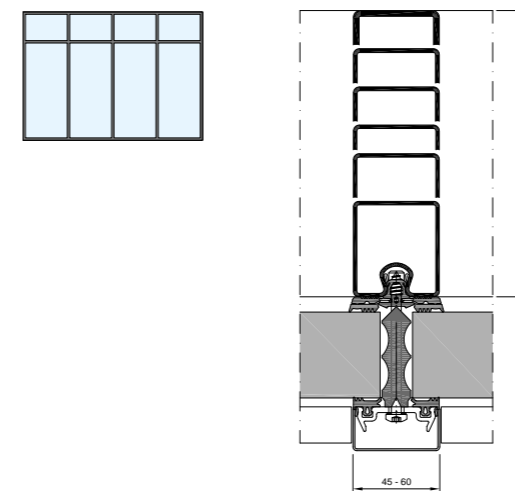

Transom



U_f 0,49 W/(m²·K)

List of references

Berufsbildungszentrum Dithmarschen (Dithmarschen vocational training centre), Heide, Germany	9
Forster exhibition stand at BAU Munich, Germany	16, 39
Haus Welper, Germany	13
Maison de la Paix, Geneva, Switzerland	8, 40, 42
MCBA Musée Cantonal des Beaux-Arts Lausanne, Switzerland	18
Porcelain Collection, Dresden, Germany	42
Saint-Omer railway station, France	6
SuperHub Meerstad, Netherlands	8, 46
Théâtre de Carouge, Switzerland	Title, 4, 44
United Imaging Smart Medical Campus, Shanghai, China	9, 48
University Hospital Bern, Switzerland	32, 34, 36
WiSo Building, University of Cologne, Germany	7

Steel is our nature.

99.12016/10068877/12-23

For us, steel is a matter of the heart. We develop long-lasting systems for attractive and energy-efficient architecture.

Forster Profile Systems develops and manufactures safe, energy-efficient solutions in steel and stainless steel for doors, windows and facades in Switzerland. Forster works with its own branches in over 20 countries – and exclusive sales partners in around 10 more. In-house consultants are on hand to assist our customers at sites ranging from Europe and the Middle East to Asia and North America. Forster systems are used for building shells and interiors. This includes market-leading solutions that meet

the strictest requirements and standards in terms of thermal insulation, plus safety applications such as fire protection, burglar resistance and bullet resistance. The product range is rounded off by matching accessories. Our customers and business partners in architecture, planning and construction can also count on comprehensive services for their respective industry.

Forster Profilsysteme AG | CH-8590 Romanshorn
info@forstersystems.com | forstersystems.com

forster